

Varenummer: 203180M24100C3U

Beskrivelse: E+G Justerfod
GN 31-80-M24-100-C3-U

Note: U Uden møtrik, sekskant i toppen, spændeflade i bunden

Mål

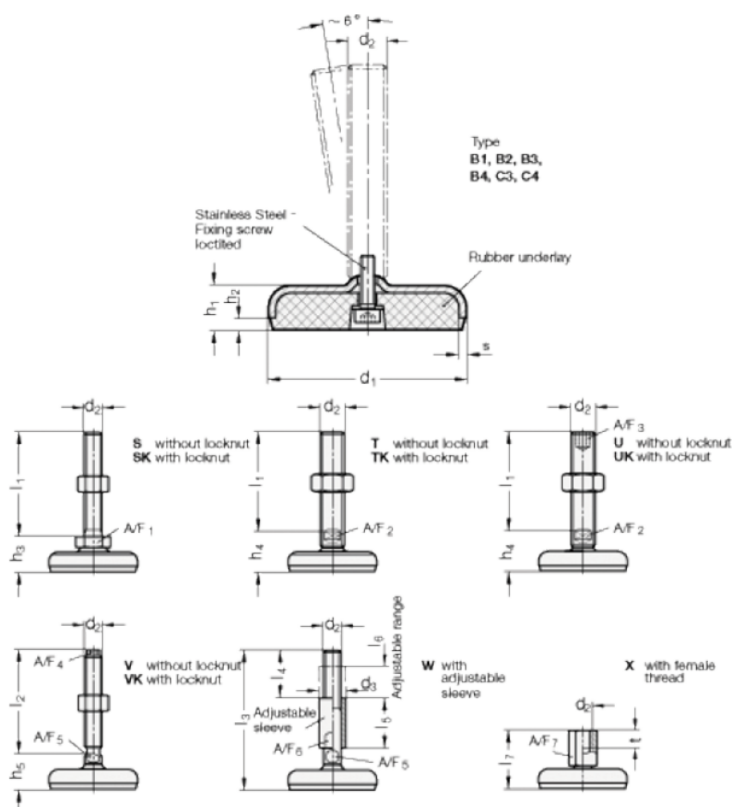

A/F2	= 19
A/F3	= 12
d1	= 80
d2	= 24
h1	= 18
h2	= 5
h4 +4.0/0	= 36
l1	= 100

s = 3